

















# EVERYBODY FEEL THE FORCE

Tuned percussion: xylophone  
chorus 1, 2 and 3

1	+	2	+	3	+	4	+	1	+	2	+	3	+	4	+
Listen for the first word of the chorus 'A ...' and then play:															
															
															
															
															
															
															
															

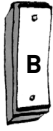
chorus 1 and 2 - continued

1	+	2	+	3	+	4	+	1	+	2	+	3	+	4	+
															

verse 2

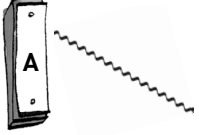
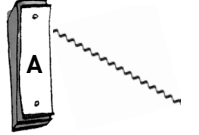
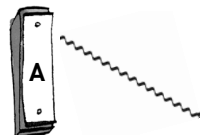
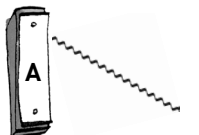
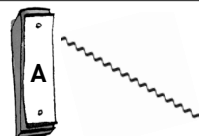
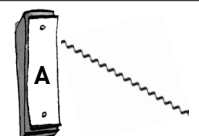
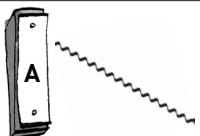
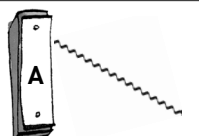
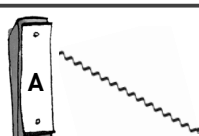
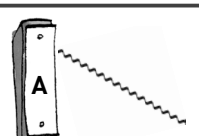
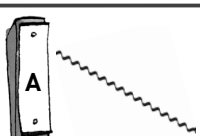
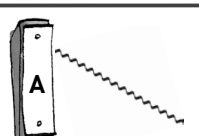
1	+	2	+	3	+	4	+	1	+	2	+	3	+	4	+
								it will tum- ble to the...							
(Listen for the end of the first line and then play)															
															
															
															

verse 2 - continued

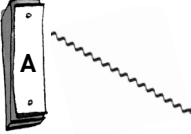
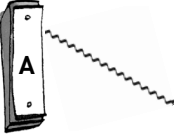
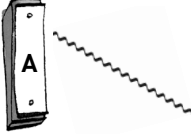
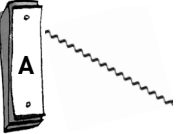
1	+	2	+	3	+	4	+	1	+	2	+	3	+	4	+
															

# chorus 4

1	+	2	+	3	+	4	+	1	+	2	+	3	+	4	+
Listen for the first word of the chorus 'A ...' and then play:															
